

Contents

1 Instructions	28
1.1 General safety instructions	28
1.2 Appliance purpose	32
1.3 Manufacturer's liability	32
1.4 Disposal	32
1.5 Identification plate	33
1.6 This user manual	33
1.7 How to read the user manual	33
2 Description	34
2.1 General Description	34
2.2 Cooking zones	34
2.3 Symbols	36
3 Use	37
3.1 Preliminary operations	37
3.2 Using the cooking hob	38
4 Cleaning and maintenance	41
4.1 Cleaning the surfaces	41
4.2 Ordinary weekly cleaning	41
4.3 Food stains or residues	41
4.4 What to do if...	42
5 Installation	43
5.1 Safety instructions	43
5.2 Section cut from the countertop	43
5.3 Mounting	46
5.4 Electrical connection	47
5.5 Instructions for the installer	50

TRANSLATION OF THE ORIGINAL INSTRUCTIONS

We advise you to read this manual carefully, which contains all the instructions for maintaining the appliance's aesthetic and functional qualities.

For further information on the product: www.smeg.com



1 Instructions

1.1 General safety instructions

Risk of personal injury

- During use the appliance and its accessible parts become very hot. Never touch the heating elements during use.
- Protect your hands by wearing heat-proof gloves during use.
- Never try to put out a fire or flames with water: Turn off the appliance and smother the flames with a fire blanket or other appropriate cover.
- This appliance may be used by children aged at least 8 and by people of reduced physical, sensory or mental capacity, or lacking in experience in the use of electrical appliances, provided that they are supervised or instructed by adults who are responsible for their safety.
- Children must not play with the appliance.
- Keep children under the age of eight at a safe distance unless they are constantly supervised.
- Keep children under the age of 8 away from the appliance when it is in use.
- Cleaning and maintenance must not be carried out by unsupervised children.
- Be aware of how rapidly the cooking zones heat up. Do not let pans heat up when dry, as there is a danger of them overheating.
- Fats and oils can catch fire if they overheat. Do not leave the appliance unattended while preparing foods containing oils or fats. If fats or oils catch fire, never put water on them. Place the lid on the pan and turn off the relevant cooking zone.
- The cooking process must always be monitored. A short cooking process must be continuously monitored.



- Do not place metal objects, such as dishes or cutlery, on the hob surface during use as they may overheat.
- Do not insert pointed metal objects (cutlery or utensils) into the slots in the appliance.
- Do not pour water directly onto very hot trays.
- Do not use or store flammable materials near the appliance or directly underneath the hob.
- Do not use aerosols in the vicinity of this appliance whilst it is in use.
- Switch off the appliance immediately after use.
- Do not modify this appliance.
- Always use any necessary/required personal protective equipment (PPE) before performing any work on the appliance (installation, maintenance, positioning or movement).
- Before performing any work on the appliance, switch off the power supply.
- Have qualified personnel carry out installation and assistance interventions according to the standards in force.
- Do not try to repair the appliance yourself or without the intervention of a qualified technician.
- If the power supply cable is damaged, contact technical support immediately and they will replace it.

Risk of damaging the appliance

- Do not use abrasive or corrosive detergents (e.g. scouring powders, stain removers and metallic sponges) on glass parts.
- Use wooden or plastic utensils.
- Do not seat on the appliance.
- Do not use the hob as a support surface.
- Do not obstruct ventilation openings and heat dispersal slots.
- Do not use steam jets to clean the appliance.



Instructions

- Never leave the appliance unattended during cooking operations where fats or oils could be released, as these could then heat up and catch fire. Be very careful.
- Fire hazard: Never leave objects on the cooking surfaces.
- Do not use the appliance to heat rooms for any reason.
- Cooking vessels or griddle plates should be placed inside the perimeter of the hob.
- All pans must have smooth, flat bottoms.
- If any liquid does boil over or spill, remove the excess from the hob.
- Take care not to spill acid substances such as lemon juice or vinegar on the hob.
- Do not spill sugar or sweet mixtures on the hob during cooking.
- Do not place materials or substances that could melt (plastic or aluminium foil).
- Do not put empty pans or frying pans on switched on cooking zones.
- Do not use rough or abrasive materials or sharp metal scrapers.
- Do not use cleaning products containing chlorine, ammonia or bleach on parts made of steel or that have metallic surface finishes (e.g. anodizing, nickel- or chromium-plating).

Installation

- This appliance **must not be installed** in a boat or caravan.
- Position the appliance into the cabinet cut-out with the help of a second person.
- Check that the carcass material is heat resistant.
- Check that the carcass has the required openings.



- To avoid potential overheating, the appliance must not be installed behind a decorative door or a panel.
- Have the electrical connection performed by authorised technical personnel.
- The appliance must be connected to earth in compliance with electrical system safety standards.
- Use cables withstanding a temperature of at least 90°C.
- The tightening torque of the screws of the terminal supply wires must be 1.5 - 2 Nm.
- The power cable must only be installed or replaced by a qualified technician.
- Avoid hard, solid objects falling on the cooking surface.
- Do not use the hob if the pyrolytic cycle is taking place inside any oven installed below.
- Do not touch or clean the hob surface during operation or when the residual heat indicator lights are still on.
- Activate the controls lock when you have children or pets which could reach the hob.
- After use the cooking zones remain hot for a certain period of time after they have been turned off. Do not touch the hob surfaces.
- Keep sensor keys clean at all times and do not rest any object on them.

For this appliance

- If cracks or fissures form, or if the glass ceramic cooking surface breaks, turn off the appliance immediately. Disconnect the power supply and call Technical Support.



Instructions

1.2 Appliance purpose

- This appliance is intended for cooking food in the home environment. Every other use is considered improper.
- The appliance is not designed to operate with external timers or with remote-control systems.

1.3 Manufacturer's liability

The manufacturer declines all liability for damage to persons or property caused by:

- Use of the appliance other than that specified;
- Failure to comply with the instructions in the user manual;
- Tampering with any part of the appliance;
- The use of non-original spare parts.

1.4 Disposal



This appliance must be disposed of separately from other waste (Directives 2002/95/EC, 2002/96/EC, 2003/108/EC). The appliance does not contain substances in quantities sufficient to be considered hazardous to health and the environment, in accordance with current European directives.

To dispose of the appliance:



Power voltage

Danger of electrocution

- Disconnect the mains power supply.
- Deliver the appliance to the appropriate recycling centre for electrical and electronic equipment waste, or return it to the retailer when purchasing an equivalent product, on a one for one basis.



Our appliances are packaged in non-polluting and recyclable materials.

- Deliver the packing materials to the appropriate recycling centre.



Plastic packaging Danger of suffocation

- Do not leave the packaging or any part of it unattended.
- Do not let children play with the plastic bags.

1.5 Identification plate

The identification plate bears the technical data, serial number and brand name of the appliance. Do not remove the identification plate for any reason.

1.6 This user manual

This user manual is an integral part of the appliance and must therefore be kept in its entirety and within the user's reach for the whole working life of the appliance.

Read this user manual carefully before using the appliance.

1.7 How to read the user manual

This user manual uses the following reading conventions:

Instructions



General information on this user manual, on safety and final disposal.

Description



Description of the appliance and its accessories.

Use



Information on the use of the appliance and its accessories, cooking advice.

Cleaning and maintenance



Information for proper cleaning and maintenance of the appliance.

Installation



Information for the qualified technician: Installation, operation and inspection.



Safety instructions



Information



Advice

1. Sequence of instructions for use.

- Standalone instruction.



Description

2 Description

2.1 General Description

The appliance features cooking zones with various diameters and power levels depending on the model. The position and the heat of the cooking zones are limited to within the diameters of the circles traced on the glass.

The cooking zones are of the **HIGH-LIGHT** type, they turn on after a few seconds and the heating is adjustable using the controls on the front panel.

The cooking zones with two concentric rings allow dual heating: either the inner ring or both rings can be used for cooking.

2.2 Cooking zones

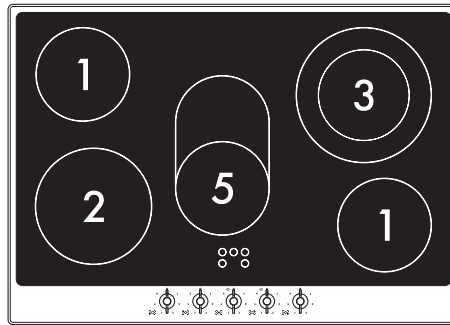

72 cm models with frame

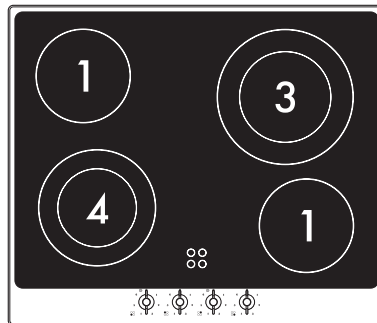

60 cm models with frame

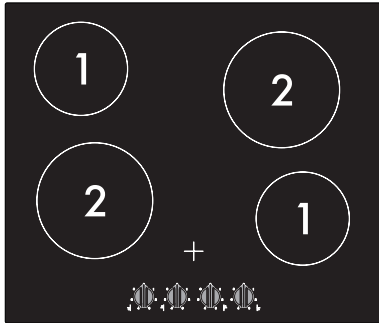

60 cm models with straight edge

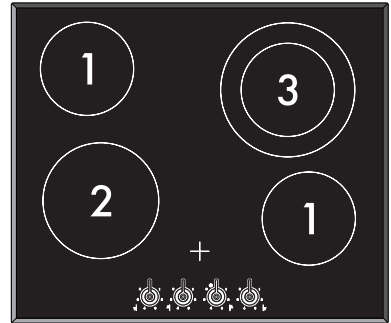

60 cm models with bevelled edge

EN

Zone	Outer diameter (mm)	Max. power draw (W)*	Inner diameter (mm)	Max. power draw (W)*
1	148	1200	-	-
2	184	1800	-	-
3	214	2200	148	1000
4	184	2000	124	800
5	oval plate	2000	148	1100

* power levels are approximate and may vary according to the settings made and the mains voltage.



Description

2.3 Symbols

Knobs

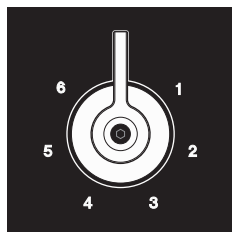
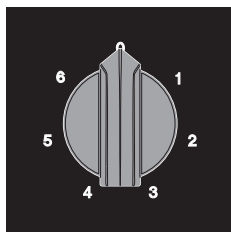
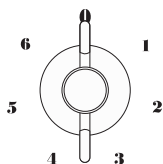

Press and turn the knob clockwise or anticlockwise to increase or decrease the power level of the cooking zone, which ranges from a minimum of **1** to a maximum of **6**.

If the  symbol is present, the knob controls the dual heating zone (on some models only).

Cooking zones

 /  /  Front left

 /  /  Rear left

 /  /  Rear right

 /  /  Front right

 Central



3 Use



High temperature Danger of burns

- Protect your hands by wearing heat-proof gloves during use.
- Do not touch or clean the hob surface during operation or when the residual heat indicator lights are still on.
- Do not put empty pans or frying pans on switched on cooking zones.
- Keep children under the age of 8 away from the appliance when it is in use.
- After use the cooking zones remain hot for a certain period of time after they have been turned off. Do not touch the hob surfaces.



High temperature Danger of fire or explosion

- Do not use or leave flammable materials near the appliance or directly underneath the hob.
- Do not cook in closed tins or containers, plastic kitchenware or containers.
- Do not leave the appliance unattended during cooking operations where fats or oils could be released.
- In case you notice cracks or fissures or you cannot turn off the appliance, disconnect the power supply and contact the Assistance Centre.



Improper use Risk of damage to surfaces

- Do not use the hob if the pyrolytic cycle is taking place inside any oven installed below.
- Never place pans with bases which are not perfectly flat and smooth.
- Avoid hard, solid objects falling on the cooking surface.
- In case you notice cracks or fissures, turn off the appliance immediately, disconnect the power supply and contact Technical Support.
- Do not use the hob as a support surface.

3.1 Preliminary operations

In order to remove any moisture that could have accumulated during the manufacturing process and for the electronic circuits and control keypad to work properly:

1. Remove the protective films from the external surfaces of the appliance and accessories.
2. Remove any labels (apart from the technical data plate).



3.2 Using the cooking hob

Switching on the cooking zones

The appliance has cooking zones of different diameters and power levels. Their positions and the edges of the heated area are shown by the markings on the glass.

The cooking zones are of the **HIGH-LIGHT** type: they turn on after a few seconds and the heat can be adjusted using the controls on the front panel.

To turn the cooking zones on, press and turn the knob to the required position between **1** and **6**.

The indicator lights located between the cooking zones turn on when the temperature of one or more radiant heating zones exceeds **60°C**.

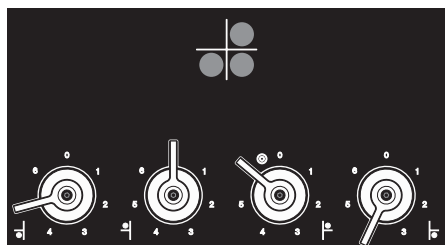
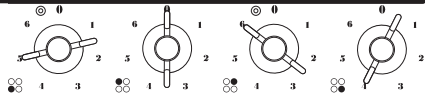

Switching off the cooking zones

To switch off the cooking zones, turn the corresponding knobs to **0**.

Dual heating zones (on some models only)

To turn on the double heating zones, press and turn the knob to the maximum setting

(6) and then to .

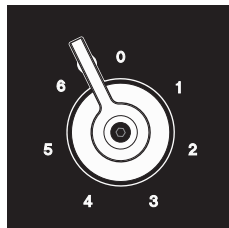
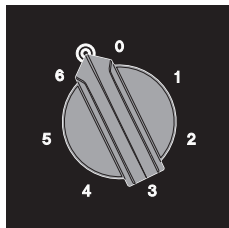
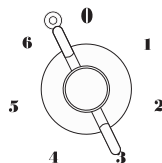

When the knob is released, it automatically returns to the highest power position.

To regulate the power of the dual heating plate, turn the knob to the required position between **1** and **6**.

To go back to using just the central hot plate, turn the knob to **0** and then press it and turn it to the required position between **1** and **6**.



Residual heat



Improper use Danger of burns

- Children cannot readily see the residual heat indicator. The cooking zones remain hot for a certain period of time even after they have been turned off. Make sure that children never touch the hob.

The indicator lights located between the cooking zones turn on when the temperature of one or more radiant heating zones exceeds **60°C**. These indicator lights turn off when the temperature falls to below approximately **60°C**.

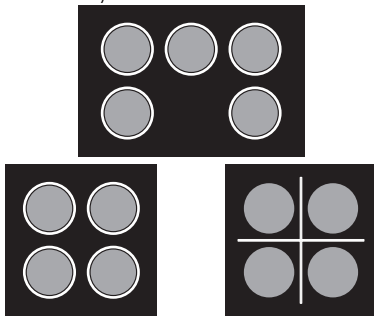

Advice on energy-saving

- The diameter of the base of the pan must correspond to the diameter of the cooking zone.



- When buying a saucepan, check whether the diameter indicated is that of the base or the top of the container, as the top is almost always larger than the base.
- The base of the cookware must be thick and completely flat. It should also be clean and dry. The hob should be clean and dry as well.
- When preparing dishes with long cooking times, you can save time and energy by using a pressure cooker, which also makes it possible to preserve the vitamins in the food.
- Make sure that the pressure cooker contains enough liquid as, if there is not enough and it overheats, this may cause damage to both the pressure cooker and the cooking zone.
- If possible, always cover saucepans with a suitable lid.
- Choose a pan suitable for the quantity of food to be cooked. A large, half-empty saucepan leads to a waste of energy.
- Do not use cast-iron cookware or cookware with a rough base.



Under certain circumstances, if the hob and the oven are being used at the same time, the maximum power limit that can be used by the electrical system might be exceeded.



Use

Cooking information table

Power level	Cooking mode	Suitable for...
0	OFF setting	Off
1	Cooking small amounts of food (minimum power)	Melting butter, chocolate or similar products.
2	Cooking small amounts of food	Keeping small amounts of water on the boil, whipping up sauces with egg yolk or butter.
3	Normal cooking	Heating solid or liquid food, keeping water on the boil, defrosting deep-frozen food, cooking 2 or 3 egg omelettes, fruit and vegetables, various cooking processes.
4	Cooking large amounts of food, roast	Stewing meat, fish and vegetables, simmering food, making jams, etc.
5	Roasting larger pieces, frying with flour	Roasting meat, fish, steaks and liver; sautéing meat, fish, eggs, etc.
6	Roasting, browning, cooking (maximum power)	Deep-frying potatoes, etc., or bringing water to the boil rapidly.



4 Cleaning and maintenance



Improper use Risk of damage to surfaces

- Do not use steam jets to clean the appliance.
- Do not spill sugar or sweet mixtures on the hob during cooking.
- Do not place materials or substances that could melt (plastic or aluminium foil).
- Keep sensor keys clean at all times and do not rest any object on them.
- Do not use cleaning products containing chlorine, ammonia or bleach on parts made of steel or that have metallic surface finishes (e.g. anodizing, nickel- or chromium-plating).
- Do not use abrasive or corrosive detergents (e.g. scouring powders, stain removers and metallic sponges) on glass parts. Use wooden or plastic utensils.

4.1 Cleaning the surfaces

To keep the surfaces in good condition, they should be cleaned regularly after use. Let them cool first.

4.2 Ordinary weekly cleaning

Clean and maintain the hob once a week using an ordinary glass cleaning product. Always follow the manufacturer's instructions. The silicon in these products creates a protective, water-repellent membrane which also resists dirt. All marks stay on the membrane and can therefore be removed easily. After cleaning, dry the surface with a clean cloth. Make sure that there is no detergent left on the cooking surface as it will undergo a corrosive reaction when heated up and could modify the structure of the cooking surface.

4.3 Food stains or residues

Light coloured marks from pans with aluminium bases can be easily cleaned off with a cloth moistened in vinegar.

After cooking, remove any burnt residues, rinse with water and dry thoroughly with a clean cloth.

Dirt which may have fallen on the hob while cleaning lettuce or potatoes can scratch the hob when moving pans.

Consequently, remove any dirt from the cooking surface immediately.

Changes in colour do not affect the operation and stability of the glass. These are not alterations to the material of the hob but just residues which have not been removed and have then carbonised.



Cleaning and maintenance

Shiny surfaces can form due to the bases of pans, especially aluminium ones, rubbing on the surface, and due to the use of unsuitable detergents. They are difficult to remove using conventional cleaning products. It may be necessary to repeat the cleaning process several times. Use of corrosive detergents or rubbing of pan bases can wear away the decoration on the hob over time and contribute to the formation of stains.

4.4 What to do if...

The hob does not work:

- Make sure that the hob is connected and that the main switch is turned on.
- Make sure that there is no power failure.
- Make sure that the fuse has not blown. In this case replace the fuse.
- Make sure that the circuit breaker of the residential electrical system has not tripped. In this case, reset the circuit breaker.
- Make sure that the sensor keys are not locked by the Controls lock.
- Make sure that the keys are not partially covered by a damp cloth, a liquid or a metal object.

The cooking results are unsatisfactory:

- Make sure that the cooking temperature is not too high or too low.

The hob smokes:

- Let the hob cool down and clean it once cooking is complete.
- Make sure that the food has not spilled out of the pan and use a larger cooking vessel, if needed.

The display shows "E2":

- Make sure that there is no spilled food on the sensor keys.
- Remove any pan or object that are partially resting on the sensor keys.

"E" appears on the display:

- One of the keys has been kept pressed for a long time or a technical fault has occurred. In the latter case, contact Technical Support.

The fuses blow or the circuit breaker of the residential electrical system trips repeatedly.

- Call Technical Support or an electrician.

There are cracks or fissures in the hob:

- Turn off the appliance immediately, disconnect the power supply and contact Technical Support.



5 Installation

5.1 Safety instructions



Heat production during appliance operation
Risk of fire

- Check that the carcass material is heat resistant.
- Check that the carcass has the required openings.
- **CAUTION:** The surface temperature exceeds 95°C . To avoid a hazard, under bench access must be restricted.

Veneers, adhesives or plastic coatings on adjacent furniture should be temperature-resistant ($>90^{\circ}\text{C}$), otherwise they might warp over time.

The minimum clearance between a ventilation hood and the cooking surface must be at least the distance indicated in the ventilation hood installation instructions.

The minimum clearances must also be respected for the edges of the hob on the back as indicated in the mounting illustrations.

5.2 Section cut from the countertop



The following operation requires building and/or carpentry work and must therefore be carried out by a competent tradesman.

Installation can be carried out on various materials such as masonry, metal, solid wood or plastic laminated wood as long as they are heat resistant ($>90^{\circ}\text{C}$).

Make a hole in the countertop of the unit according to the dimensions shown in the figure (mm).

Hobs with bevelled edge

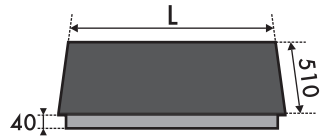

L	X	Y
600	565	490
720	685	490

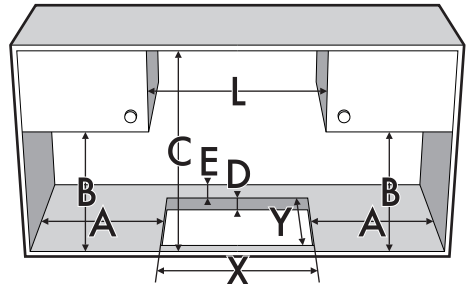

A	B	C	D	E
min. 50	min. 460	min. 750	20-60	min. 50



Installation

Hob seal

To prevent leakage of liquid between the frame of the hob and the countertop, place the adhesive seal provided along the entire outer edge of the hob before assembly.

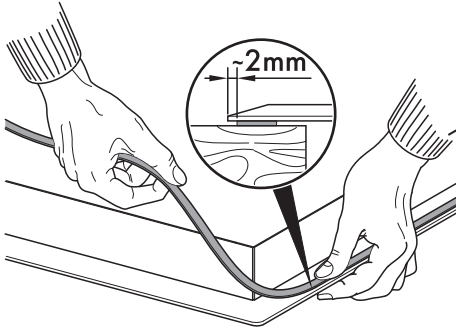

Do not use silicone to secure the hob. This would make it impossible to remove the hob, if necessary, without damaging it.

Hobs with a straight edge

For this kind of hobs additional milling is needed in the recessed hole if you wish to install the hob flush with the work surface.

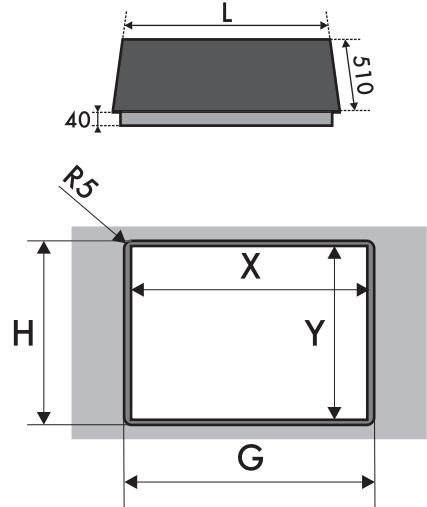

L	X	Y	G	H
600	565	490	604	514

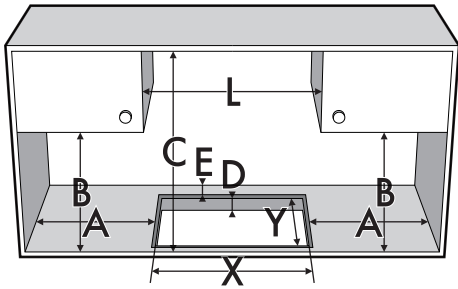

A	B	C	D	E
min. 50	min. 460	min. 750	20-60	min. 50

After laying the adhesive seal (**A**) on the glass surface and after positioning and securing the hob, fill the edges with insulating silicone (**B**) and wipe away any excess.

In the event the hob needs to be removed, cut the silicone using a cutter before attempting to remove it (**C**).

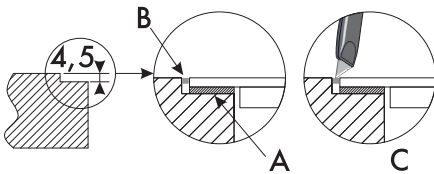

Spring clips

To ensure the hob is fixed and centred as accurately as possible, the clips provided must be positioned as described below:

1. Fit the clips by gently pressing them horizontally into the appropriate space.

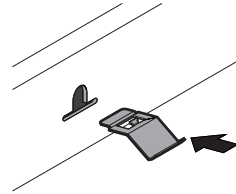

2. Then turn them upwards to fix them in place.

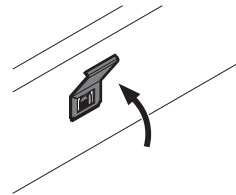



Installation

Fixing brackets

- Screw the fixing brackets into the holes on the sides of the bottom casing to properly fasten the hob to the structure.

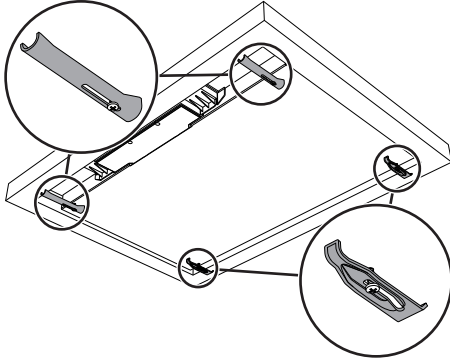

If tightened too much the glass may be strained and crack.

5.3 Mounting

Over built-in oven unit

The clearance between the hob and the kitchen furniture or other installed appliances must be enough to ensure sufficient ventilation and air discharge.

If installed above an oven, a space must be left between the bottom of the hob and the top of the appliance installed below.

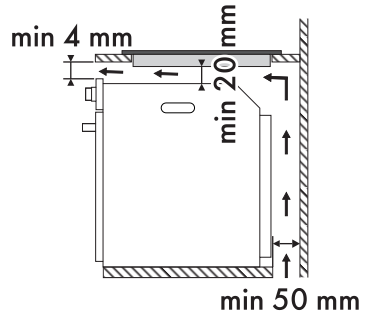

If installed on top of an oven, the latter must be equipped with a cooling fan.



On top of an empty kitchen unit or drawers

If there are other pieces of furniture (lateral walls, drawers, etc.), dishwashers or fridges under the hob, a double-layer wooden base must be installed at least **20 mm** from the bottom of the hob to avoid any accidental contact. It must only be possible to remove the double-layer base by using suitable tools.

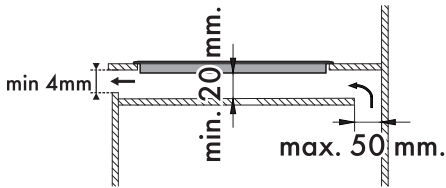
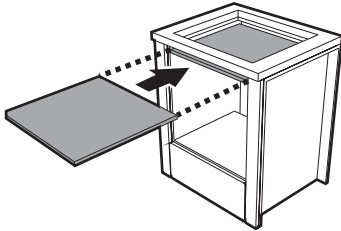

opens on bottom

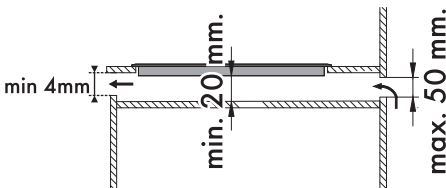

opens on rear



Failure to install the double-layer wooden base exposes the user to possible accidental contact with sharp or hot parts.

5.4 Electrical connection



Power voltage
Danger of electrocution

- Have the electrical connection performed by authorised technical personnel.
- Use personal protective equipment.
- The appliance must be connected to earth in compliance with electrical system safety standards.
- Disconnect the mains supply.
- Use cables withstanding a temperature of at least 90°C.
- The tightening torque of the screws of the terminal supply wires must be 1.5 - 2 Nm.
- **The power cable must only be installed or replaced by a qualified technician.**
- Use the cable provided (depending on the model) following the instructions below.



Installation

General information

Check the grid characteristics against the data indicated on the plate.

The identification plate bearing the technical data, serial number and brand name is visibly positioned on the appliance.

Do not remove this plate for any reason.

Perform the ground connection using a wire that is 20 mm longer than the other wires.

Connection with plug and socket

Make sure that the plug and socket are of the same type.

Avoid using adapters and shunts as these could cause overheating and a risk of burns.

The diagram below illustrates the power supply terminal from below, with no cables connected. Terminals **4** and **5** must be connected at all times.

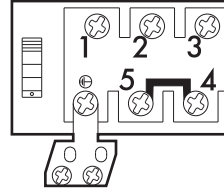

- **220-240 V 1N~**

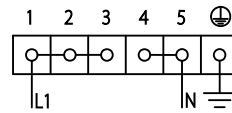

- **220-240 V 2~**

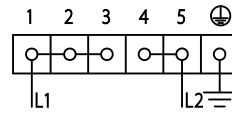

3 x 6 mm² three-core cable.



If the cable is replaced, the appliance can also function in the following modes:

- **380-415 V 2N[~]**

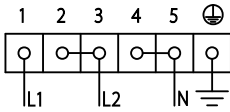

4 x 4 mm² four-core cable.

- **220-240 V 3[~]**

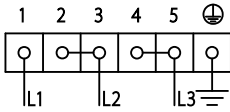

4 x 4 mm² four-core cable.

- **380-415 V 3N[~]**

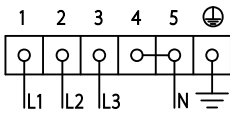

5 x 2.5 mm² five-core cable.

Fixed connection

Fit the power line with an omnipolar circuit breaker in compliance with installation regulations.

The circuit breaker should be located near the appliance and in an easily reachable position.



Run the power cable in the rear part of the unit. Make sure that it does not come into contact with the lower part of the hob or a built-in oven below it.



Be careful when connecting additional electrical appliances. Connection cables must not come into contact with hot cooking zones.

Testing

At the end of installation, carry out a brief inspection test. If it fails to work, after making sure that you have carried out the instructions correctly, contact Technical Support.



5.5 Instructions for the installer

- Do not bend or trap the power cable.
- The appliance must be installed according to the installation diagrams.
- If the appliance does not work correctly after having carried out all the checks, contact your local Authorised Service Centre.
- Once the appliance has been installed, please explain to the user how to use it correctly.